

## Basic characteristics data

Model	Circuit method	Switching frequency [KHz]	Input current	Rated input fuse	Inrush current protection circuit	PCB/Pattern			Series/Redundancy operation availability	
						Material	Single sided	Double sided	Series operation	Redundancy operation
CES	Forward converter	420	*1	-	-	glass fabric base, epoxy resin		Multilayer	Yes	*2
CES (type-P)	Forward converter	400	*1	-	-	glass fabric base, epoxy resin		Multilayer	Yes	*2
CQS	Forward converter	420	*1	-	-	glass fabric base, epoxy resin		Multilayer	Yes	*2

\*1 Refer to Specification.

\*2 Refer to Instruction Manual.

CES · CQS

<b>1</b>	<b>Pin Connection</b>	CE/CQ-10
<b>2</b>	<b>Connection for Standard Use</b>	CE/CQ-10
<b>3</b>	<b>Wiring Input/Output Pin</b>	CE/CQ-10
	3.1 Wiring input pin .....	CE/CQ-10
	3.2 Wiring output pin .....	CE/CQ-11
<b>4</b>	<b>Function</b>	CE/CQ-12
	4.1 Overcurrent protection .....	CE/CQ-12
	4.2 Overvoltage protection .....	CE/CQ-12
	4.3 Thermal protection .....	CE/CQ-12
	4.4 Remote ON/OFF .....	CE/CQ-12
	4.5 Remote sensing .....	CE/CQ-12
	4.6 Adjustable voltage range .....	CE/CQ-13
	4.7 Isolation .....	CE/CQ-14
<b>5</b>	<b>Series and Parallel Operation</b>	CE/CQ-14
	5.1 Series operation .....	CE/CQ-14
	5.2 Redundancy operation .....	CE/CQ-14
<b>6</b>	<b>Implementation · Mounting Method</b>	CE/CQ-15
	6.1 Mounting method .....	CE/CQ-15
	6.2 Automatic Mounting (CES series:option S) .....	CE/CQ-15
	6.3 Soldering .....	CE/CQ-15
	6.4 Stress onto the pins .....	CE/CQ-16
	6.5 Cleaning .....	CE/CQ-16
	6.6 Storage method (CES series:option S) .....	CE/CQ-16
	6.7 Stress to the product .....	CE/CQ-16
<b>7</b>	<b>Safety Considerations</b>	CE/CQ-16
<b>8</b>	<b>Derating</b>	CE/CQ-16
	8.1 CES Derating .....	CE/CQ-16
	8.2 CQS Derating .....	CE/CQ-20
<b>9</b>	<b>SMD type(optionS) package information</b>	CE/CQ-22

CE/CQ

# 1 Pin Connection

## ●CES Series

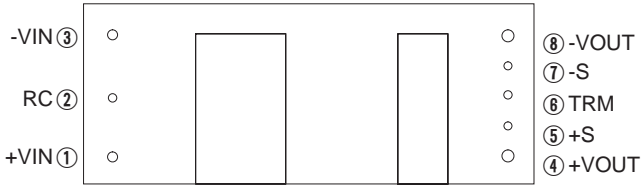

## ●CQS Series

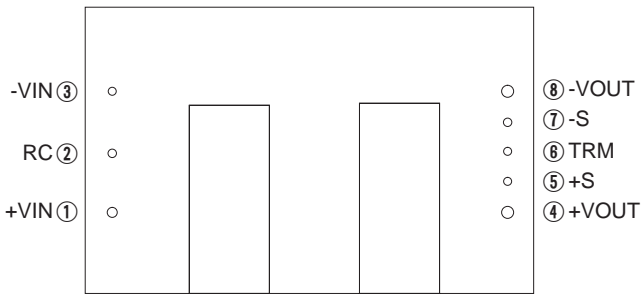

Fig.1.1 Pin Connection (bottom view)

Table 1.1 Pin Connection and function

No.	Pin Connection	Function
①	+VIN	+DC input
②	RC	Remote ON/OFF
③	-VIN	-DC input
④	+VOUT	+DC output
⑤	+S	+Remote sensing
⑥	TRM	Adjustment of output voltage
⑦	-S	-Remote sensing
⑧	-VOUT	-DC output

No.	Pin Connection	Reference
①	+VIN	3.1 "Wiring input pin "
②	RC	4.4 "Remote ON/OFF "
③	-VIN	3.1 "Wiring input pin "
④	+VOUT	3.2 "Wiring output pin "
⑤	+S	4.5 "Remote sensing "
⑥	TRM	4.6 "Adjustable voltage range "
⑦	-S	4.5 "Remote sensing "
⑧	-VOUT	3.2 "Wiring output pin "

# 2 Connection for Standard Use

■In order to use the power supply, it is necessary to wire as shown in Fig.2.1.

Reference : 3 "Wiring Input/Output Pin"  
8 "Derating"

■Short the following pins to turn on the power supply.

-VIN↔RC, +VOUT↔+S, -VOUT↔-S

Reference : 4.4 "Remote ON/OFF"  
4.5 "Remote sensing"

■The CES series and the CQS series handle only the DC input.

Avoid applying AC input directly.

It will damage the power supply.

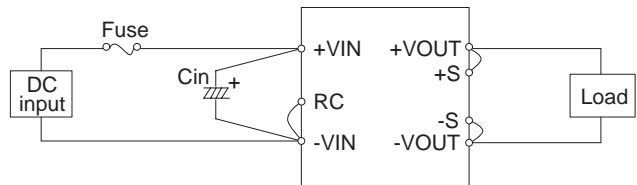

Cin : External capacitor on the input side

Fig.2.1 Connection for standard use

Table 2.1 Recommended External capacitor on the input side

Model	CES24/CQS24	
Cin	220μF or more	
Model	CES48/CQS48	CES48033-30, CES48050-20, CES48060-17, CES48033-30P, CES48050-20P, CES48120-7P
Cin	33μF or more	47μF or more

# 3 Wiring Input/Output Pin

## 3.1 Wiring input pin

(1) External fuse

■Fuse is not built-in on input side. In order to protect the unit, install the normal-blow type fuse on input side.

■When the input voltage from a front end unit is supplied to multiple units, install the normal-blow type fuse in each unit.

Table 3.1 Recommended fuse (Normal-blow type)

Model	CES24	CQS24	CES48	CQS48
Rated current	10A	15A	6.3A	10A

CES · CQS

(2) External capacitor on the input side

■ Install an external capacitor  $C_{in}$ , between +VIN and -VIN input pins for low line-noise and for stable operation of the power supply.

- Capacitance Refer to Table 2.1
- $T_a = -20$  to  $+85^\circ\text{C}$  Electrolytic or Ceramic capacitor
- $T_a = -40$  to  $+85^\circ\text{C}$  Ceramic capacitor

■  $C_{in}$  is within 50mm for pins. Make sure that ripple current of  $C_{in}$  should be less than rate.

(3) Recommended of noise-filter

■ Install an external input filter as shown in Fig.3.1 in order to reduce conducted noise.  $C_{in}$  is shown in Table 2.1.

The result for this solution is shown in Fig.3.2.

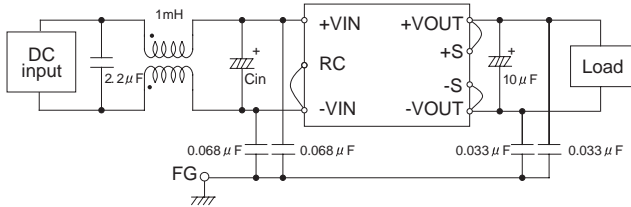

Fig.3.1 Recommended external input filter

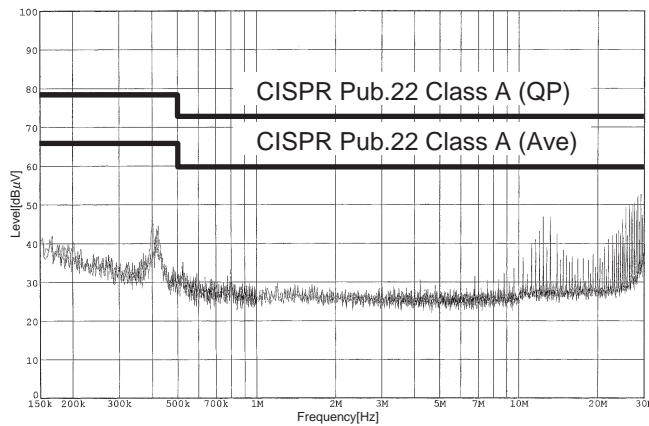

Fig.3.2 Conducted noise (CES48033-25)

(4) Reverse input voltage protection

■ Avoid the reverse polarity input voltage. It will damage the power supply.

It is possible to protect the unit from the reverse input voltage by installing an external diode as shown in Fig.3.3.

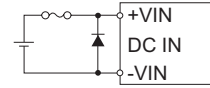

Fig.3.3 Reverse input voltage protection

3.2 Wiring output pin

■ When the CES series or the CQS series supplies the pulse current for the pulse load, please install capacitor  $C_o$  between +VOUT and -VOUT pins.

Recommended capacitance of  $C_o$  is shown in Table 3.2.

■ If output current is decreased rapidly, output voltage rises transiently and the overvoltage protection circuit may operate.

In this case, please install capacitor  $C_o$ .

■ Select the high frequency type capacitor. Output ripple and start-up waveform may be influenced by ESR · ESL of the capacitor and the wiring impedance.

■ Make sure that ripple current of  $C_o$  should be less than rate.

Table 3.2 Recommended capacitance  $C_o$

No.	Output voltage	CES	CQS
1	1.5 - 3.3V	0 - 20,000µF	0 - 40,000µF
2	5V, 6V	0 - 10,000µF	0 - 20,000µF
3	12V, 15V	0 - 1,000µF	0 - 2,200µF

■ Ripple and Ripple Noise are measured, as shown in the Fig.3.4.  $C_{in}$  is shown in Table 2.1.

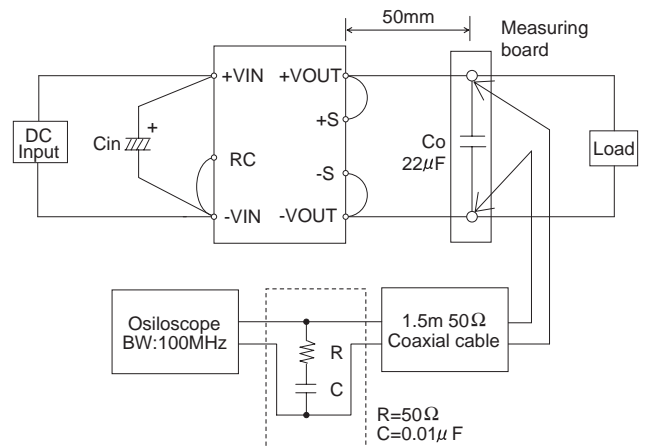

Fig.3.4 Measuring method of Ripple and Ripple Noise

# 4 Function

## 4.1 Overcurrent protection

Overcurrent protection is built-in and comes into effect at over 105% of the rated current.

Overcurrent protection prevents the unit from short circuit and overcurrent condition.

The DC output will be shut down, when the output voltage drops under the output voltage adjustment range (low voltage protection).

In this case, recovery from low voltage protection is accomplished by cycling the DC input power off for at least 1 second(★), or toggling Remote ON/OFF signal.

★The recovery time varies depending on input voltage and input capacity.

## 4.2 Overvoltage protection

The overvoltage protection circuit is built-in. The DC input should be shut down if overvoltage protection is in operation.

In this case, recovery from overvoltage protection is accomplished by cycling the DC input power off for at least 1 second(★), or toggling Remote ON/OFF signal.

★The recovery time varies depending on input voltage and input capacity.

### Remarks :

Please note that devices inside the power supply might fail when voltage more than rated output voltage is applied to output pin of the power supply. This could happen when the customer tests the overvoltage performance of the unit.

## 4.3 Thermal protection

When the power supply temperature is kept above 120°C, the thermal protection will be activated and simultaneously shut down the output.

In this case, the unit should be cool down, and then recovery from thermal protection is accomplished by cycling the DC input power off for at least 1 second, or toggling Remote ON/OFF signal.

### ●-N

Option "-N" means auto restart from thermal protection.

## 4.4 Remote ON/OFF

Remote ON/OFF circuit is built-in on input side (RC).

The ground pin of input side remote ON/OFF circuit is "-VIN" pin.

Table 4.1.1 Specification of Remote ON/OFF

	ON/OFF logic	Between RC and -VIN	Output voltage
Standard	Negative	L level(0 - 0.8V) or short	ON
		H level(2.0 - 7.0V) or open	OFF
Optional -R	Positive	L level(0 - 0.8V) or short	OFF
		H level(2.0 - 7.0V) or open	ON

When RC is "Low" level, fan out current is 0.1mA typ. When Vcc is applied, use  $2.0 \leq V_{cc} \leq 7.0V$ .

Table 4.1.2 Specification of Remote ON/OFF (type-P)

	ON/OFF logic	Between RC and -VIN	Output voltage
Standard	Negative	L level(0 - 0.8V) or short	ON
		H level(4.0 - 7.0V) or open	OFF
Optional -R	Positive	L level(0 - 0.8V) or short	OFF
		H level(4.0 - 7.0V) or open	ON

When RC is "Low" level, fan out current is 0.1mA typ. When Vcc is applied, use  $4.0 \leq V_{cc} \leq 7.0V$ .

When remote ON/OFF function is not used, please short between RC and -VIN(-R: open between RC and -VIN).

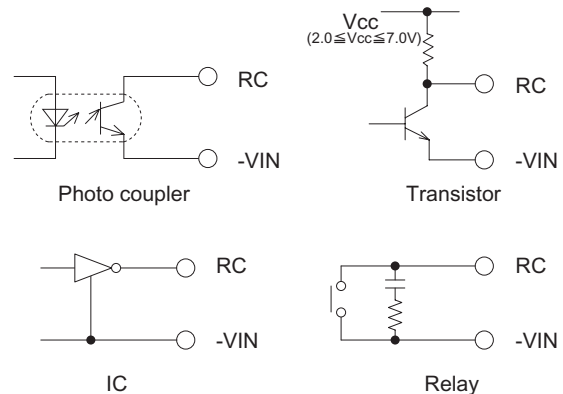

Fig.4.1 RC connection example

## 4.5 Remote sensing

(1) When the remote sensing function is not in use

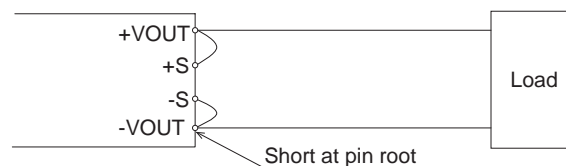

Fig.4.2 Connection when the remote sensing is not in use

CES · CQS

- When the remote sensing function is not in use, it is necessary to confirm that pins are shorted between +S & +VOUT and between -S & -VOUT.
- Wire between +S & +VOUT and between -S & -VOUT as short as possible. Loop wiring should be avoided. This power supply might become unstable by the noise coming from poor wiring.

(2)When the remote sensing function is in use

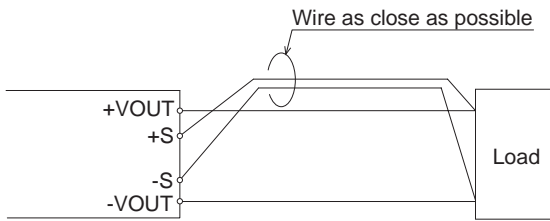

Fig.4.3 Connection when the remote sensing is in use

- Twisted-pair wire or shield wire should be used for sensing wire.
- Thick wire should be used for wiring between the power supply and a load. Line drop should be less than 0.3V. Voltage between +VOUT and -VOUT should remain within the output voltage adjustment range.
- If the sensing patterns are short, heavy-current is drawn and the pattern may be damaged. The pattern disconnection can be prevented by installing the protection parts as close as a load.
- Output voltage might become unstable because of impedance of wiring and load condition when length of wire is exceeding 40cm.

4.6 Adjustable voltage range

(1) Output voltage adjusting

- Output voltage is adjustable by the external potentiometer.
- When the output voltage adjustment is used, note that the over voltage protection circuit operates when the output voltage sets too high.
- If the output voltage drops under the output voltage adjustment range, note that the Low voltage protection operates.
- By connecting the external potentiometer (VR1)and resistors (R1,R2),output voltage becomes adjustable, as shown in Fig.4.4, recommended external parts are shown in Table 4.2.
- The wiring to the potentiometer should be as short as possible. The temperature coefficient becomes worse, depending on the type of a resistor and potentiometer. Following parts are recommended for the power supply. Resistor.....Metal film type, coefficient of less than ±100ppm/°C Potentiometer.....Cermet type, coefficient of less than ±300ppm/°C
- When the output voltage adjustment is not used, open the TRM pin respectively.

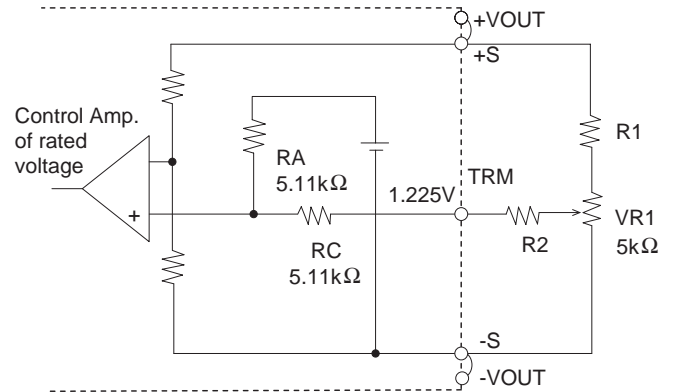

Fig.4.4 Output voltage control circuit

Table 4.2 Recommended value of external potentiometer & resistor

No.	VOUT	Output adjustable range					
		VOUT ±5%			VOUT ±10%		
		R1	R2	VR1	R1	R2	VR1
1	1.5V	0	10kΩ	5kΩ	0	4.3kΩ	5kΩ
2	1.8V	0	39kΩ		0	18kΩ	
3	2.5V	330Ω	68kΩ		560Ω	33kΩ	
4	3.3V	2.2kΩ	68kΩ		2.2kΩ	33kΩ	
5	5V	4.7kΩ	68kΩ		5.6kΩ	33kΩ	
6	6V	5.6kΩ	68kΩ		6.8kΩ	33kΩ	
7	12V	18kΩ	68kΩ		18kΩ	33kΩ	
8	15V	22kΩ	68kΩ		22kΩ	33kΩ	

(2) Output voltage decreasing

- By connecting the external resistor(RD), output voltage becomes adjustable to decrease. The external resistor(RD) is calculated the following equation.

$$RD = \frac{5.11}{\Delta} - 10.22 \text{ [k}\Omega\text{]}$$

$$\Delta = \frac{V_{OR} - V_{OD}}{V_{OR}}$$

V<sub>OR</sub> : Rated output voltage [V]

V<sub>OD</sub> : Output voltage needed to set up [V]

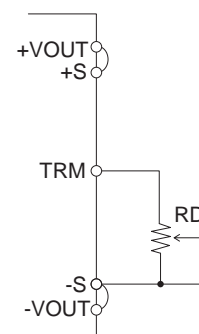

Fig.4.5 Connection for output voltage decreasing

CES · CQS

(3) Output voltage increasing

■ By connecting the external resistor (R<sub>U</sub>), output voltage becomes adjustable to increase.

The external resistor (R<sub>U</sub>) is calculated the following equation.

$$R_U = \frac{5.11 \times V_{OR} \times (1 + \Delta)}{1.225 \times \Delta} - \frac{5.11}{\Delta} - 10.22 \text{ [k}\Omega\text{]}$$

$$\Delta = \frac{V_{OU} - V_{OR}}{V_{OR}}$$

V<sub>OR</sub> : Rated output voltage [V]

V<sub>OU</sub> : Output voltage needed to set up [V]

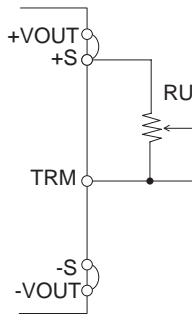

Fig.4.6 Connection for output voltage increasing

(4) Input voltage derating

■ CES24□-□ and CQS24□-□ require DC20V or more input to trim the output voltage up more than rated.

■ CES48050-20P require DC40V or more input to trim the output voltage up more than 5.5V.

4.7 Isolation

■ For a receiving inspection, such as Hi-Pot test, gradually increase (decrease) the voltage for a start (shut down). Avoid using Hi-Pot tester with the timer because it may generate voltage a few times higher than the applied voltage, at ON/OFF of a timer.

CE/CQ

5 Series and Parallel Operation

5.1 Series operation

■ Series operation is available by connecting the outputs of two or more power supplies, as shown below. Output current in series connection should be lower than the lowest rated current in each unit.

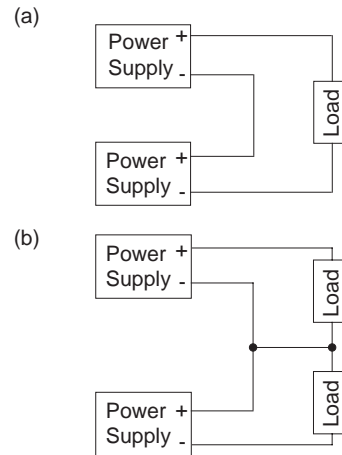

Fig.5.1 Examples of series operation

5.2 Redundancy operation

■ Parallel operation is not possible.

■ Redundancy operation is available by wiring as shown below.

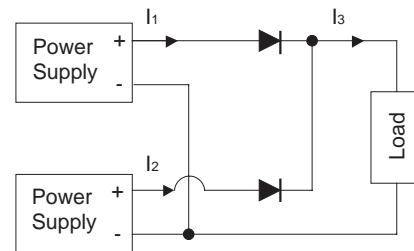

Fig.5.2 Redundancy operation

■ Even a slight difference in output voltage can affect the balance between the values of I<sub>1</sub> and I<sub>2</sub>.

Please make sure that the value of I<sub>3</sub> does not exceed the rated current of a power supply.

$$I_3 \leq \text{the rated current value}$$

## 6 Implementation · Mounting Method

### 6.1 Mounting method

- The unit can be mounted in any direction. When two or more power supplies are used side by side, position them with proper intervals to allow enough air ventilation. The temperature around each power supply should not exceed the temperature range shown in derating curve.
- Avoid placing the DC input line pattern layout underneath the unit, it will increase the line conducted noise. Make sure to leave an ample distance between the line pattern layout and the unit. Also avoid placing the DC output line pattern underneath the unit because it may increase the output noise. Lay out the pattern away from the unit.
- Avoid placing the signal line pattern layout underneath the unit, this power supply might become unstable. Lay out the pattern away from the unit.
- Avoid placing pattern layout in hatched area in Fig.6.1 to insulate between pattern and power supply.

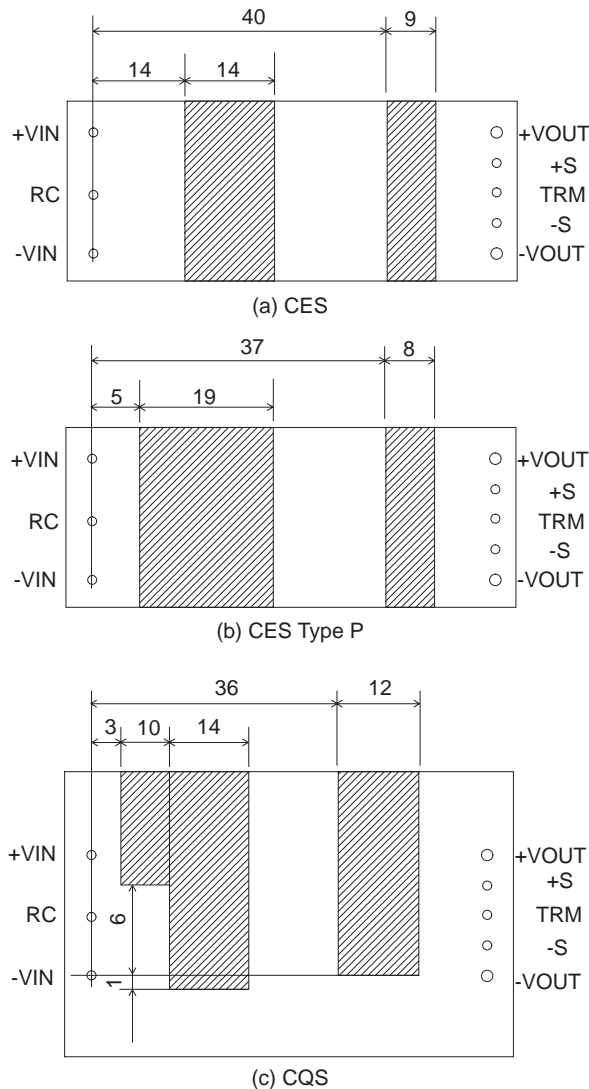

Fig.6.1 Prohibition area of pattern lay out (top view)

### 6.2 Automatic Mounting (CES series:option S)

- To mount CES series automatically, use the transformer area near the center of the PCB as a adsorption point. Please see the External View for details of the adsorption point.
- If the bottom dead point of a suction nozzle is too low when mounting excessive force is applied to the transformer, which could cause damage. Please mount carefully.

### 6.3 Soldering

(1) Flow Soldering :260°C 15 seconds or less

(2) Soldering Iron :maximum 450°C 5 seconds or less

(3) Reflow Soldering (option “-S”)

- Fig.6.2 shows conditions for the reflow soldering for option “-S” of CES series. Please make sure that the temperatures of pin terminals +VIN and -VOUT shown in Fig.6.2 do not exceed the temperatures shown in Fig.6.3.

- If time or temperature of the reflow soldering goes beyond the conditions, reliability of internal components may be compromised. Please use the unit under the recommended reflow conditions.

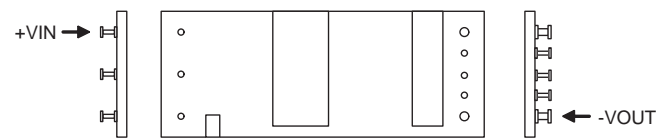
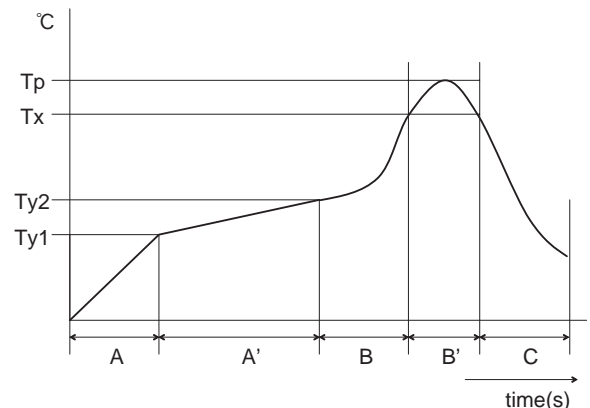

Fig.6.2 Temperature Measuring Points when Setting Reflow Soldering Conditions



A	1.0 - 5.0°C/s
A'	Ty1:160±10°C Ty2:180±10°C Ty1 - Ty2:120s max
B	1.0 - 5.0°C/s
B'	Tp:Max245°C 10s max Tx:220°C or more:70s max
C	1.0 - 5.0°C/s

Fig.6.3 Recommend Reflow Soldering Conditions



CES · CQS

●Notes to use option “-S”

- Solder iron or similar is not recommended soldering method for option “-S”. The reason is to retain connection reliability between the PCB and the Pins. Solder reflow is the acceptable mounting system for the option.
- Option “-S” is not reusable product after soldered on any application PCB.

6.4 Stress onto the pins

- When too much stress is applied to the pins of the power supply, the internal connection may be weakened. As shown in Fig.6.4, avoid applying stress of more than 19.6N (2kgf) on the pins horizontally and more than 39.2N (4kgf) vertically.
- The pins are soldered on PWB internally, therefore, do not pull or bend them with abnormal forces.
- Fix the unit on PCB (using silicone rubber or fixing fittings) to reduce the stress onto the pins.

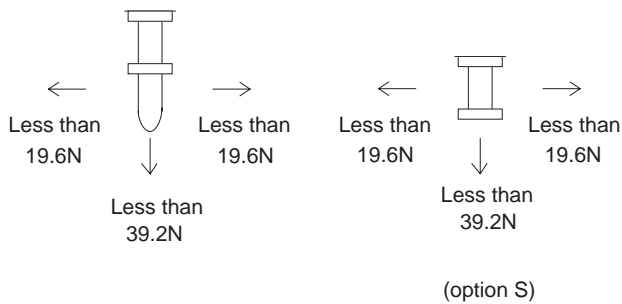

Fig.6.4 Stress onto the pins

6.5 Cleaning

- When cleaning is necessary, follow the under mentioned condition.

Method : Varnishing, ultrasonic wave and vapor  
 Cleaning agents : IPA (Solvent type)  
 Total time : 2 minutes or less

- Do not apply pressure to the lead and name plate with a brush or scratch it during the cleaning.
- After cleaning, dry them enough.

6.6 Storage method (CES series:option S)

- To stock unpacked products in your inventory, it is recommended to be kept under controlled condition, 5-30°C, 60%RH and be used within a year.
- 24-hours-baking is recommended at 125°C if unpacked products was kept under uncontrol condition, in which 30°C, 60%RH or higher. Original tray is not heat-resistant, please move them to heat-resistant tray preparing to bake them. To check moisture condition in the pack, silica gel packet has some moisture condition indicator particle. Indicated blue means good. Pink means alarm to bake it.
- Notification. The tray will be deformed and the power supply might be damaged, if the vacuum pressure is too much to reseal.

6.7 Stress to the product

- CES/CQS series transformer core and choke coil core are attached by glue. There is a possibility that the core will be removed and power supply will be damaged when it took stress by the fall or some kind of stress.

7 Safety Considerations

- To apply for safety standard approval using this power supply, the following conditions must be met.

- This unit must be used as a component of the end-use equipment.
- The equipment contain basic insulation between input and output. If double or reinforced insulation is required, it has to be provided by the end-use equipment according the final build in condition.
- Safety approved fuse must be externally installed on input side.

8 Derating

8.1 CES Derating

- Use with the convection cooling or the forced air cooling. Use the temperature measurement location as shown in Fig.8.2.1 to Fig.8.2.3 below the regulated temperature. Refer to Fig.8.1 for derating curve. Ambient temperature must keep below 85°C.

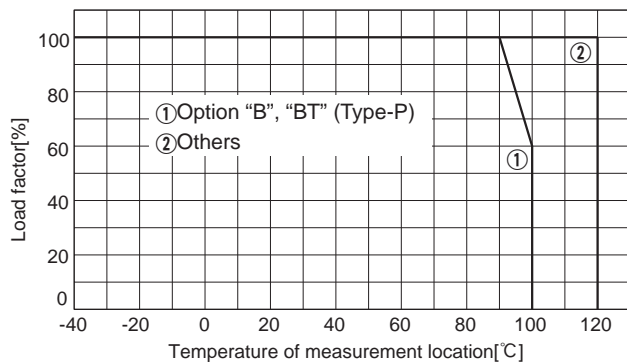
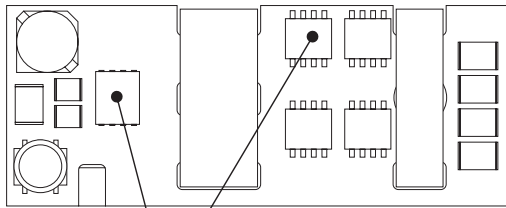

Fig.8.1 Derating curve

CE/CQ

CES · CQS



Temperature measurement location  
Fig.8.2.1 Temperature measurement location

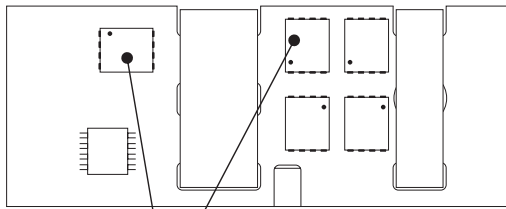

Temperature measurement location  
Fig.8.2.2 Temperature measurement location (CES Type P)

■Option “B” and “BT”(Type-P) used with the convection cooling or the forced air cooling or the conduction cooling.  
Use the temperature measurement location as shown in Fig.8.2.3.

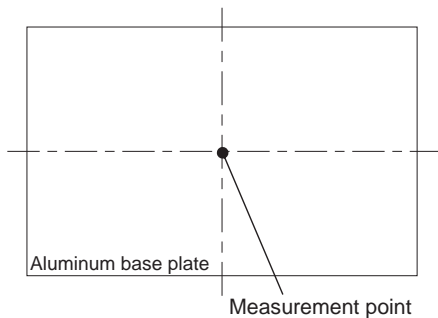

Fig.8.2.3 Measurement point (CES Type P option “B”, “BT”)

■Shown the thermal curve with measuring as shown in Fig.8.3.  
Verify final design by actual temperature measurement.  
Use the temperature measurement location as shown in Fig.8.2.1 to fig.8.2.3 at 120°C or less.

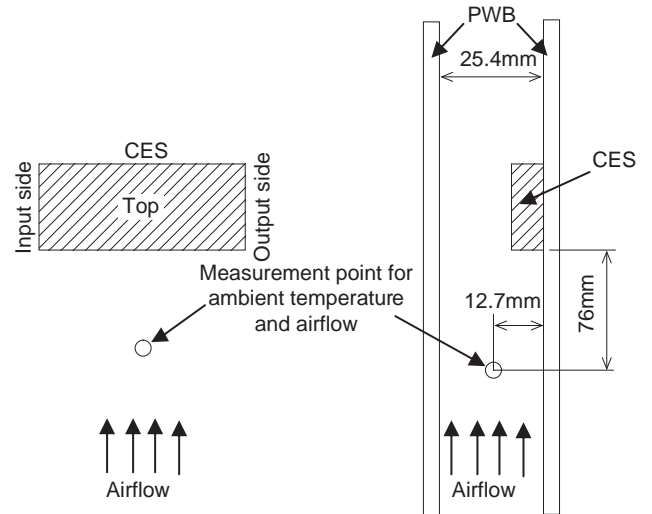

Fig.8.3 Measuring method

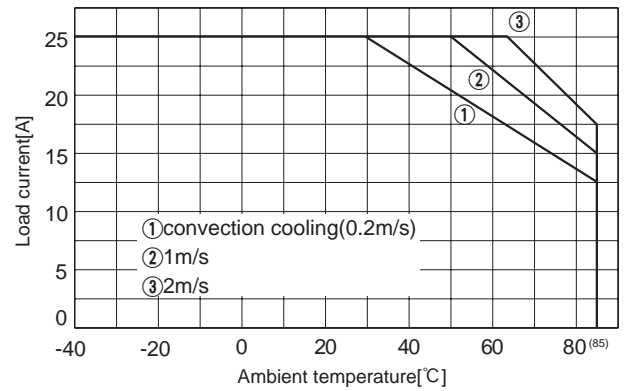

Fig.8.4 Load current vs. ambient temperature(CES24033-25 Vin=24V)

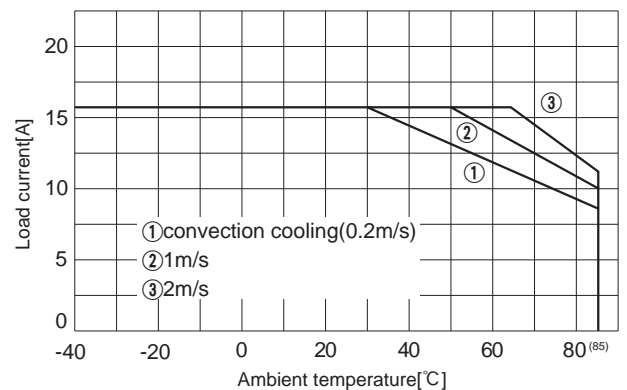

Fig.8.5 Load current vs. ambient temperature(CES24050-16 Vin=24V)

CES · CQS

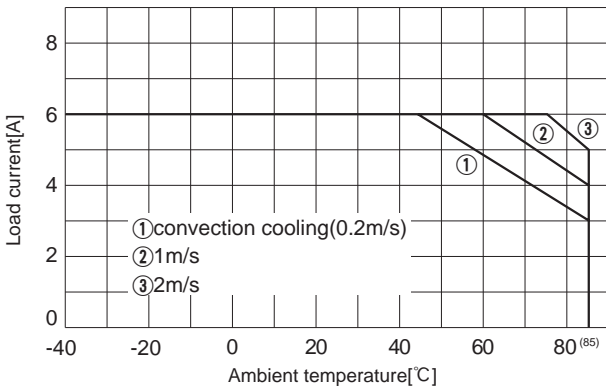

Fig.8.6 Load current vs. ambient temperature(CES24120-6 Vin=24V)

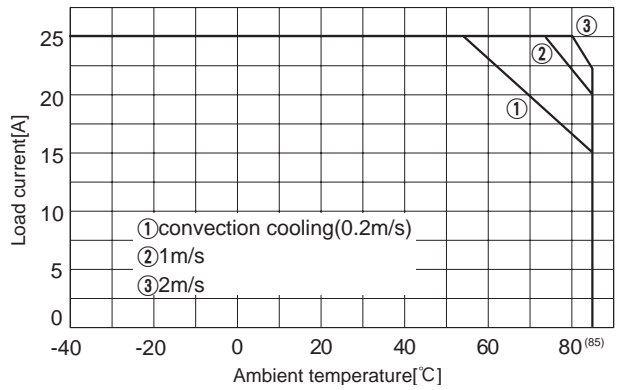

Fig.8.10 Load current vs. ambient temperature(CES48025-25 Vin=48V)

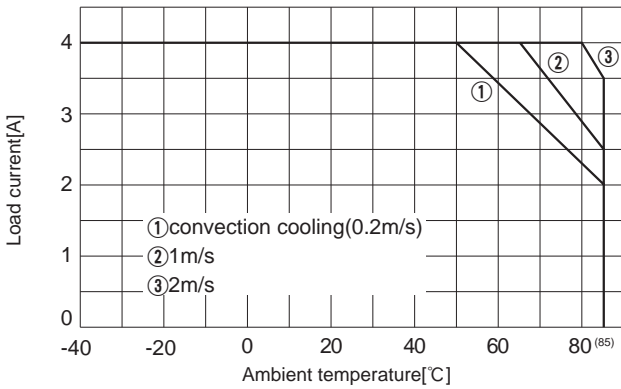

Fig.8.7 Load current vs. ambient temperature(CES24150-4 Vin=24V)

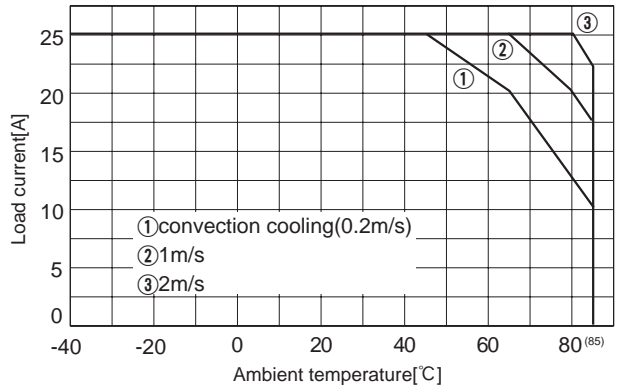

Fig.8.11 Load current vs. ambient temperature(CES48033-25 Vin=48V)

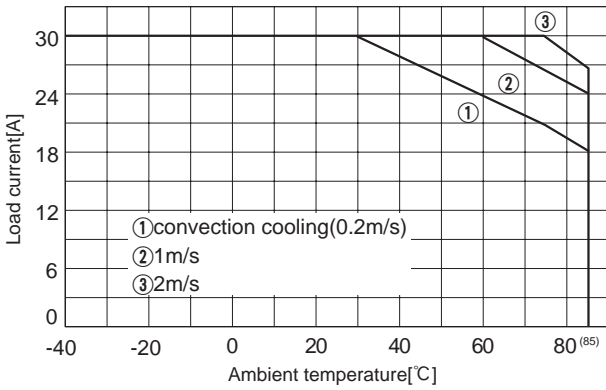

Fig.8.8 Load current vs. ambient temperature(CES48015-30 Vin=48V)

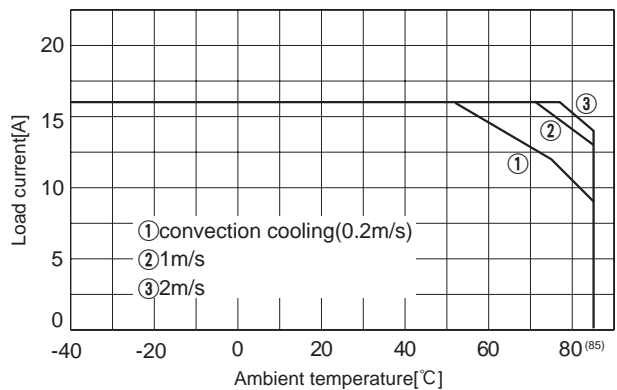

Fig.8.12 Load current vs. ambient temperature(CES48050-16 Vin=48V)

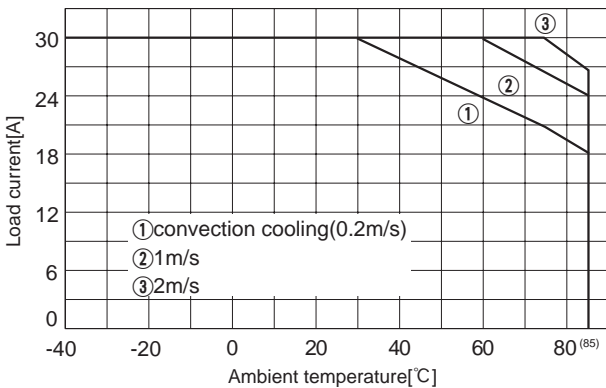

Fig.8.9 Load current vs. ambient temperature(CES48018-30 Vin=48V)

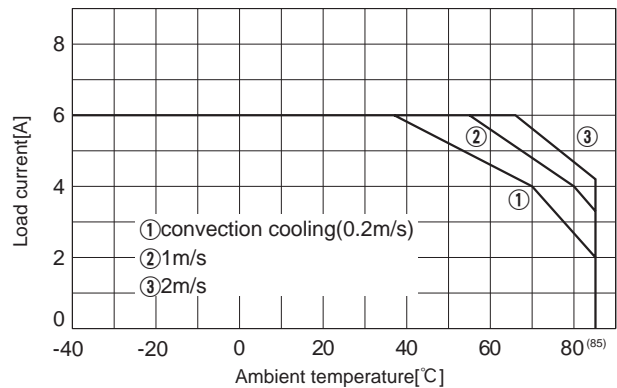

Fig.8.13 Load current vs. ambient temperature(CES48120-6 Vin=48V)

CES · CQS

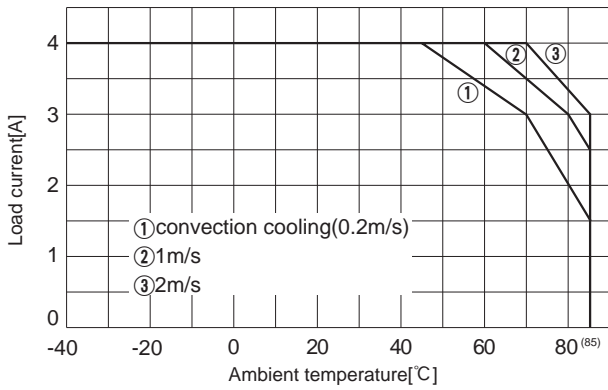

Fig.8.14 Load current vs. ambient temperature(CES48150-4 Vin=48V)

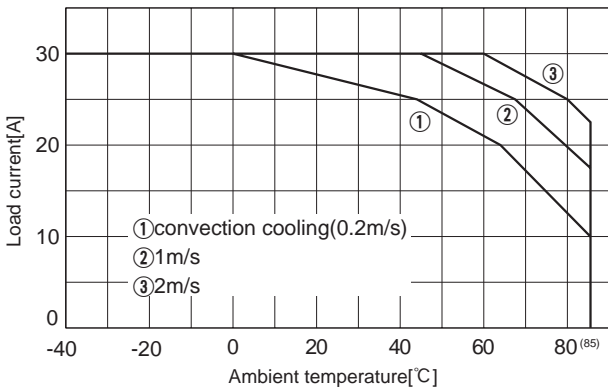

Fig.8.15 Load current vs. ambient temperature(CES48033-30 Vin=48V)

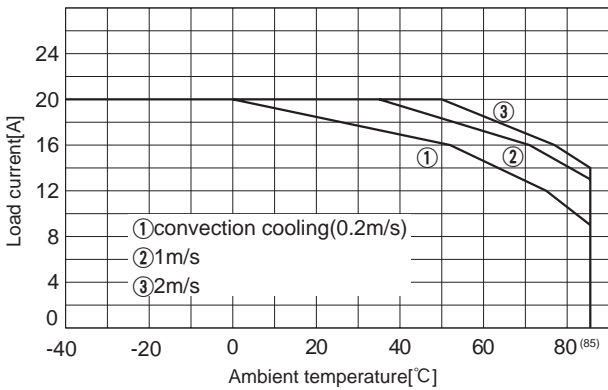

Fig.8.16 Load current vs. ambient temperature(CES48050-20 Vin=48V)

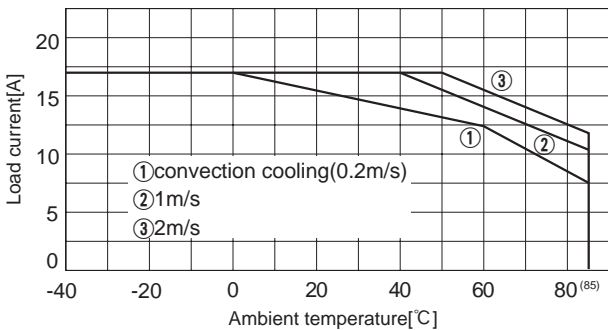

Fig.8.17 Load current vs. ambient temperature(CES48060-17 Vin=48V)

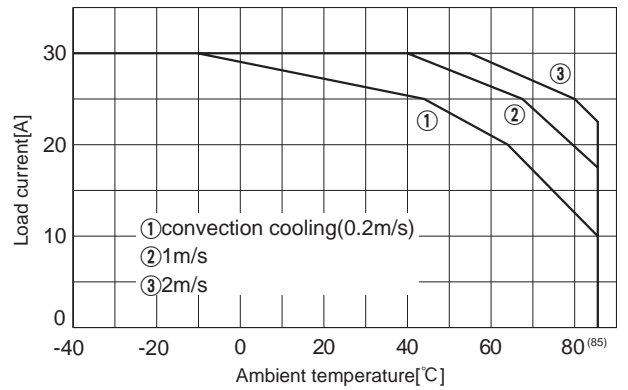

Fig.8.18 Load current vs. ambient temperature(CES48033-30P Vin=48V)

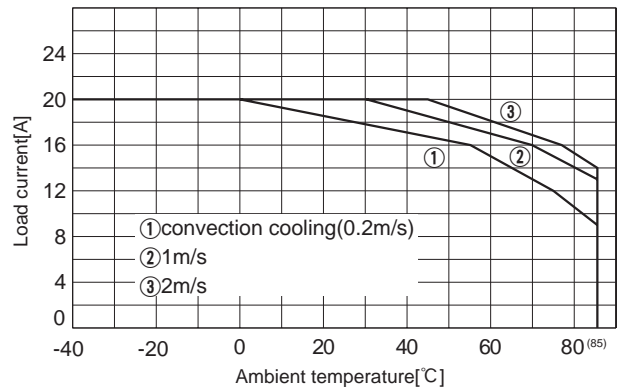

Fig.8.19 Load current vs. ambient temperature(CES48050-20P Vin=48V)

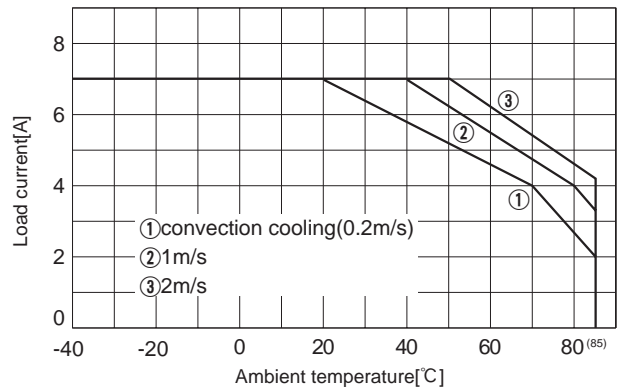

Fig.8.20 Load current vs. ambient temperature(CES48120-7P Vin=48V)

\*For other thermal curves, please consult with us.

### 8.2 CQS Derating

■ Use with the convection cooling or the forced air cooling.

Use the temperature measurement location as shown in Fig.8.21 at 120°C or less.

Ambient temperature must keep below 85°C.

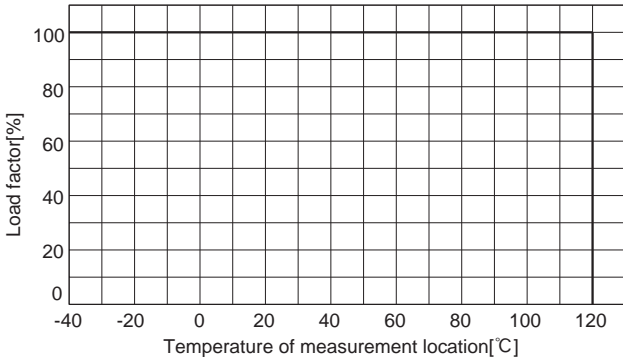
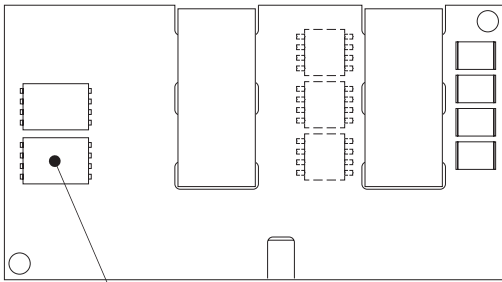
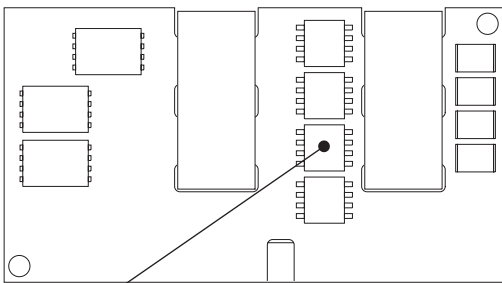

Fig.8.21 Derating curve



Temperature measurement

Fig.8.22 CQS24□□-□, Temperature measurement location



Temperature measurement

Fig.8.23 CQS48015-50, CQS48018-50, CQS48025-45, CQS48033-45, Temperature measurement location

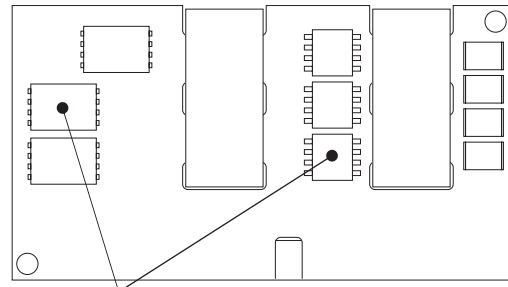

Temperature measurement

Fig.8.24 CQS48050-28, Temperature measurement location

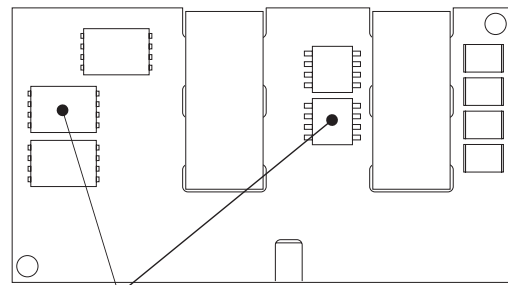

Temperature measurement

Fig.8.25 CQS48120-14, CQS48150-8

Temperature measurement location

■ Shown the thermal curve with measuring as shown in Fig.8.26.

Verify final design by actual temperature measurement.

Use the temperature measurement location as shown in Fig.8.22 to Fig.8.25 at 120°C or less.

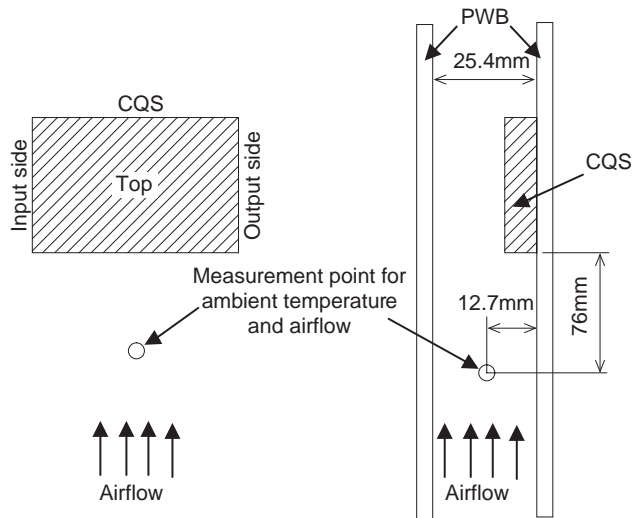

Fig.8.26 Measuring method

CES · CQS

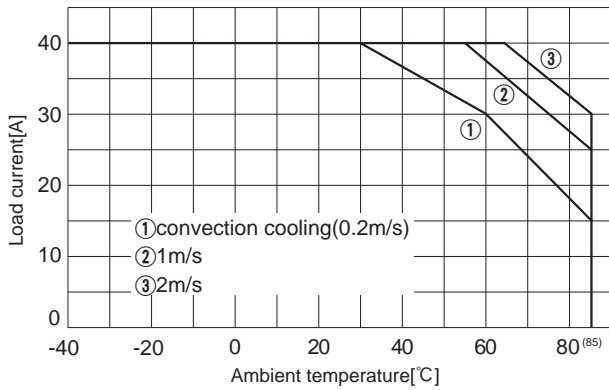

Fig.8.27 Load current vs. ambient temperature(CQS24033-40 Vin=24V)

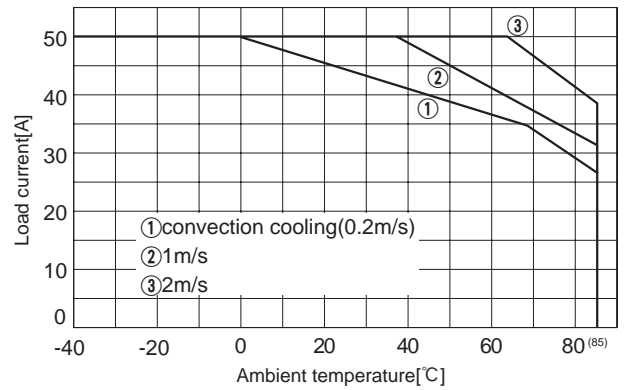

Fig.8.31 Load current vs. ambient temperature(CQS48015-50 Vin=48V)

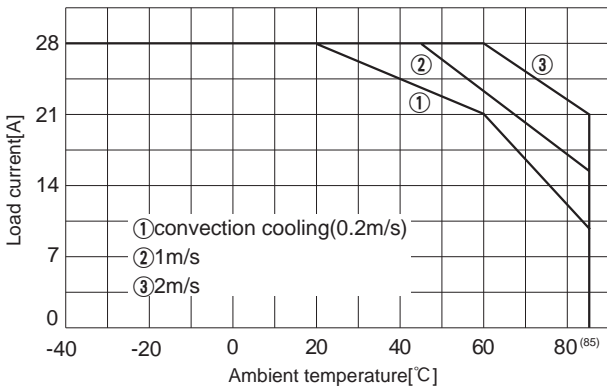

Fig.8.28 Load current vs. ambient temperature(CQS24050-28 Vin=24V)

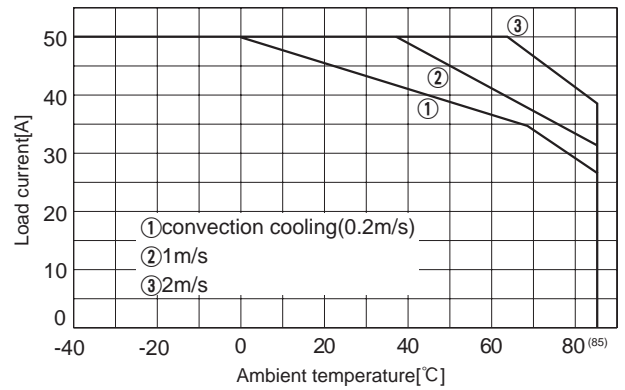

Fig.8.32 Load current vs. ambient temperature(CQS48018-50 Vin=48V)

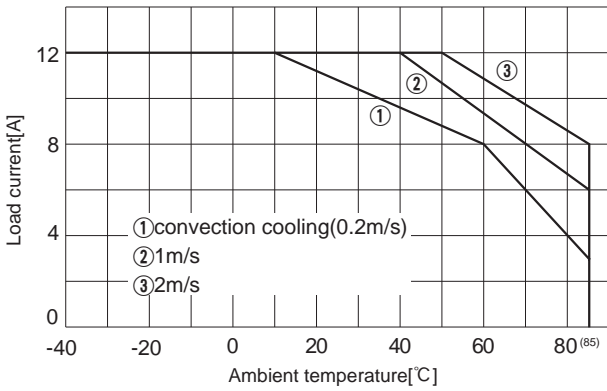

Fig.8.29 Load current vs. ambient temperature(CQS24120-12 Vin=24V)

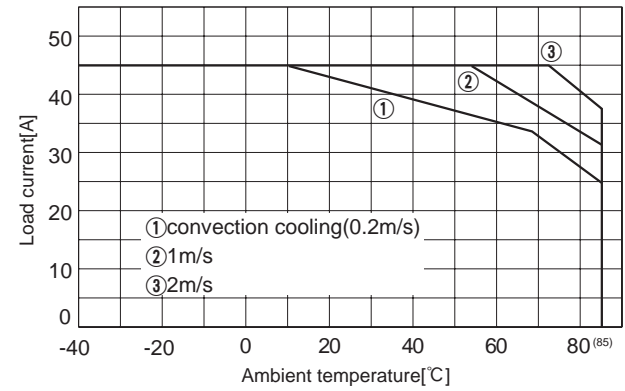

Fig.8.33 Load current vs. ambient temperature(CQS48025-45 Vin=48V)

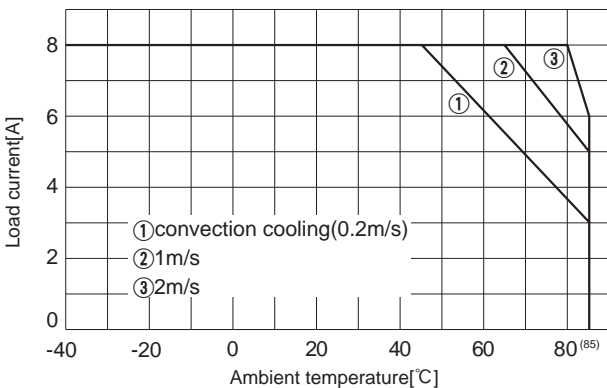

Fig.8.30 Load current vs. ambient temperature(CQS24150-8 Vin=24V)

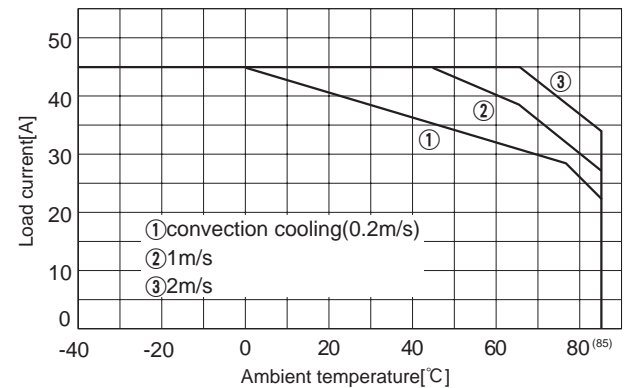

Fig.8.34 Load current vs. ambient temperature(CQS48033-45 Vin=48V)

