

MAX series

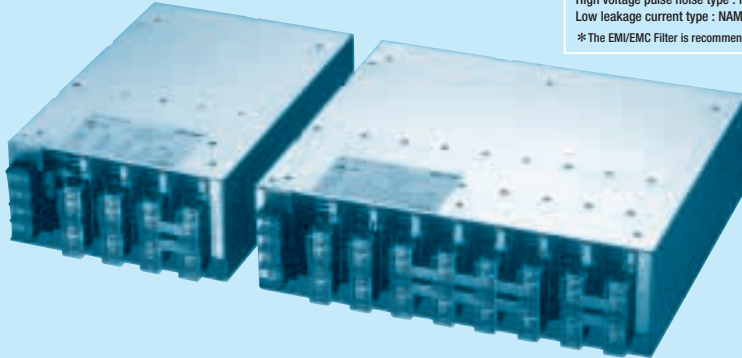
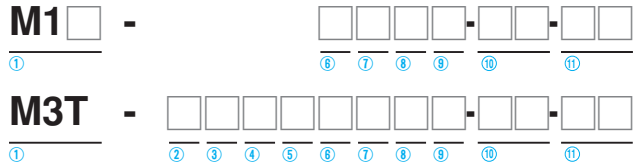

Recommended EMI/EMC Filter
 MAX1600F **NAC-30-472**
 MAX1600T **TAC-10-683**
 MAX3200T **TAC-20-683**

High voltage pulse noise type : NAP series
 Low leakage current type : NAM series
 *The EMI/EMC Filter is recommended to connect with several devices.

- ① Abbreviation type name of MAX series
 M1F : MAX1600F
 M1T : MAX1600T
 M3T : MAX3200T
- ② Slot 8 Output module
- ③ Slot 7 Output module
- ④ Slot 6 Output module
- ⑤ Slot 5 Output module
- ⑥ Slot 4 Output module
- ⑦ Slot 3 Output module
- ⑧ Slot 2 Output module
- ⑨ Slot 1 Output module
- ⑩ Parallel code
- ⑪ Series and option code *7
 Refer to instruction manual

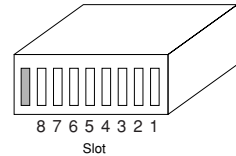

* The number of slot is different depending on the model.

SPECIFICATIONS

	MODEL	MAX1600F (M1F)	MAX1600T (M1T)	MAX3200T (M3T)	
INPUT	VOLTAGE[V]	AC85 - 264 1 φ / DC120 - 350	AC170 - 264 3 φ	AC170 - 264 3 φ	
	FREQUENCY[Hz]	47 - 63	47 - 63	47 - 63	
	CURRENT[A]	AC100V *1	19typ	-	-
		AC200V *2	10typ	6.5typ	13typ
	POWER FACTOR	AC100V *1	0.99typ	-	-
		AC200V *2	0.95typ	0.95typ	0.95typ
	INRUSH CURRENT [A]	AC100V	20/40typ (Primary inrush current/Secondary inrush current)	-	-
		AC200V	40/40typ (Primary inrush current/Secondary inrush current)	40typ	40typ
	EFFICIENCY[%]	AC100V *1	78typ	-	-
		AC200V *2	82typ	85typ	85typ
LEAKAGE CURRENT [mA] *3		1.5max	2max	2max	
OUTPUT	NUMBER OF SLOT *4	4	4	8	
	TOTAL MAXIMUM POWER[W]	AC90 - 150V *5	1500	-	-
		AC170 - 264V *5	1600	1600	3200
	START-UP TIME [ms]	AC100V *1	700typ	-	-
		AC200V *2	500typ	500typ	500typ
	HOLD-UP TIME[ms] *1		20typ	20typ	20typ
FUNCTION	ALARM	FAN ALARM	FAN AND OPEN PHASE ALARM	FAN AND OPEN PHASE ALARM	
ISOLATION	INPUT-OUTPUT, RC	AC3,000V 1minute, Cutoff current=25mA, DC500V 50MΩ min (At Room Temperature) (Cutoff current = 100mA : MAX3200T)			
	INPUT-FG	AC2,000V 1minute, Cutoff current=25mA, DC500V 50MΩ min (At Room Temperature)			
	OUTPUT, RC-FG	AC500V 1minute, Cutoff current=100mA, DC500V 50MΩ min (At Room Temperature)			
ENVIRONMENT	OPERATING TEMP., HUMID. AND ALTITUDE *5	-20 to +65°C, 20 - 90%RH (Non condensing) (Refer to DERATING CURVE), 3,000m (10,000feet) max			
	STORAGE TEMP., HUMID. AND ALTITUDE	-20 to +75°C, 20 - 90%RH (Non condensing) 9,000m (30,000feet) max			
	VIBRATION	19.6m/s ² , 10 - 55Hz, 3minutes period, 60minutes each along X, Y and Z axis			
	IMPACT	196.1m/s ² , 11ms, once each X, Y and Z axis			
SAFETY AND NOISE REGULATIONS	AGENCY APPROVALS	UL60950-1, C-UL (CSA60950-1), EN60950-1, EN50178, Complies with DEN-AN (At only AC input)			
	CONDUCTED NOISE	Complies with FCC-B, VCCI-B, CISPR22-B and EN55022-B			
	HARMONIC ATTENUATOR	Complies with IEC61000-3-2			
OTHERS	CASE SIZE *6	200 X 97 X 300mm (W X H X D) [7.87 X 3.82 X 11.81 inches]	200 X 97 X 300mm (W X H X D) [7.87 X 3.82 X 11.81 inches]	340 X 97 X 300mm (W X H X D) [13.39 X 3.82 X 11.81 inches]	
	WEIGHT	7kg max	7kg max	14kg max	
	COOLING METHOD	Forced cooling (built-in)			

*1 It is a value when M1F-HFEC-00 (MAX1600F : 5V80A, 12V34A, 15V27A, 24V17A) outputs 1500W. The value changes by composing the output modules.
 *2 It is a value when M1F-HFEC-00 (MAX1600F : 5V80A, 12V34A, 15V27A, 24V17A) outputs 1600W or M1T-HFEC-00 (MAX1600T : 5V80A, 12V34A, 15V27A, 24V17A) outputs 1600W or M3T-HHFFEECC-00 (MAX3200T : 5V80A X2, 12V34A X2, 15V27A X2, 24V17A X2) outputs 3200W. The value changes by composing the output modules.

*3 Complies with IEC60950 at AC240V 60Hz.
 *4 Each output module is insulated.
 *5 Refer to derating.
 *6 Case size contains neither the terminal blocks (cover) nor the screw.
 *7 Please contact us about safety approvals for the model with option.

Output module specifications

ITEM	CODE	A	B	C	D	E	F	G	H	I	O
Number of slots used		1	1	1	1	1	1	1	1	1	1
VOLTAGE[V]		2	3.3	5	7.5	12	15	18	24	28	BLANK PANEL
CURRENT[A]		80	80	80	54	34	27	22	17	14.5	
LINE REGULATION[mV]max		20	20	20	30	48	60	72	96	112	
LOAD REGULATION[mV]max		40	40	40	60	100	120	150	150	180	
RIPPLE [mV]max	0 to +50°C*1	80	80	80	120	120	120	120	120	120	
	-20 to 0°C*1	140	140	140	160	160	160	160	160	160	
RIPPLE NOISE [mV]max	0 to +50°C*1	120	120	120	150	150	150	150	150	150	
	-20 to 0°C*1	160	160	160	180	180	180	180	180	180	
TEMPERATURE COEFFICIENT[mV]max	0 to +50°C	40	40	50	75	120	150	180	240	280	
	-10 to +50°C	60	60	75	120	180	225	270	360	420	
DRIFT[mV]max	*2	12	12	20	30	48	60	72	96	112	
OUTPUT VOLTAGE SETTING[V]		2.00 - 2.06	3.30 - 3.40	5.00 - 5.15	7.50 - 7.80	12.00 - 12.48	15.00 - 15.60	18.00 - 18.72	24.00 - 24.96	28.00 - 29.12	
OUTPUT VOLTAGE ADJUSTMENT RANGE[V]		1.98 - 2.20	2.64 - 3.63	4.00 - 5.50	6.00 - 8.25	9.60 - 13.20	12.00 - 16.50	14.40 - 19.80	19.20 - 26.40	22.40 - 30.80	
OVERCURRENT PROTECTION		Works over 105% of rated current automatic recovery									
OVERVOLTAGE PROTECTION[V]		4.00 - 5.50	4.00 - 5.50	5.75 - 7.00	8.63 - 10.50	13.80 - 16.80	17.25 - 21.00	20.70 - 25.20	27.60 - 33.60	32.20 - 39.20	
OUTPUT CURRENT IN PARALLEL[A] *3	TWO MODULES IN PARALLEL	144	144	144	97	61	49	40	31	26	-
	THREE MODULES IN PARALLEL	216	216	216	146	92	73	60	46	40	-
	FOUR MODULES IN PARALLEL	300	300	300	195	125	100	80	63	54	-
	FIVE MODULES IN PARALLEL	360	360	360	243	153	122	100	77	66	-
	SIX MODULES IN PARALLEL	444	444	444	292	196	149	120	92	80	-
	SEVEN MODULES IN PARALLEL	516	516	516	341	217	173	140	107	94	-
	EIGHT MODULES IN PARALLEL	600	600	600	390	250	200	160	127	108	-

MAX

- *1 Measured by 20MHz oscilloscope or Ripple-Noise meter (Equivalent to KEISOKU-GIKEN : RM101).
Ripple and Ripple Noise is measured by using measuring board with capacitor of 470 μF between 20mm to 100mm from the output terminal.
- *2 Drift is change in DC output for an eight hour period after a half-hour warm-up at 25°C, with the input voltage held constant at the rated input/output.
- *3 Modularity in parallel are built to order and are not possible for the user to assemble them.

Block diagram

● MAX1600F

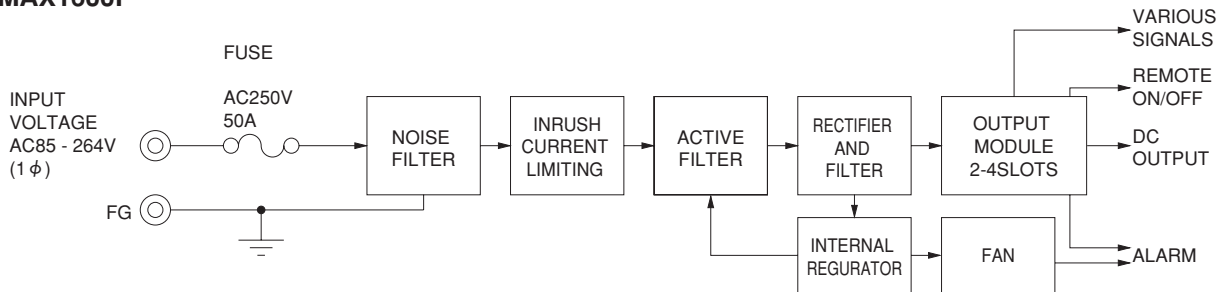

● MAX1600T / MAX3200T

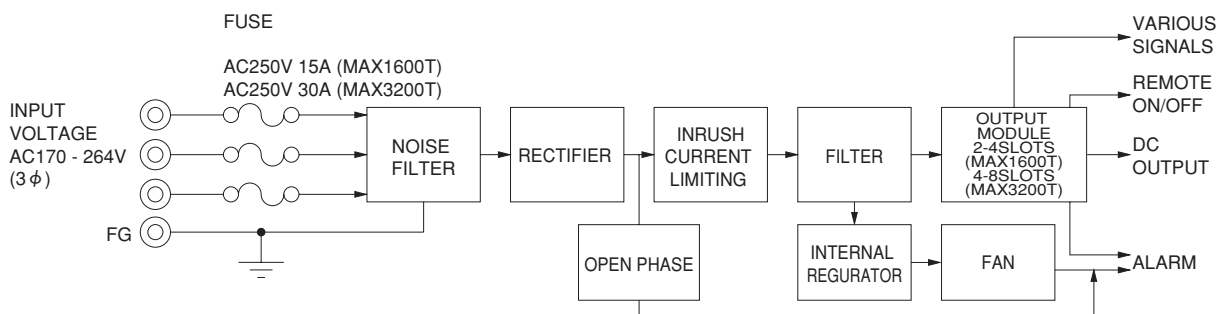

MAX1600F / MAX1600T external view

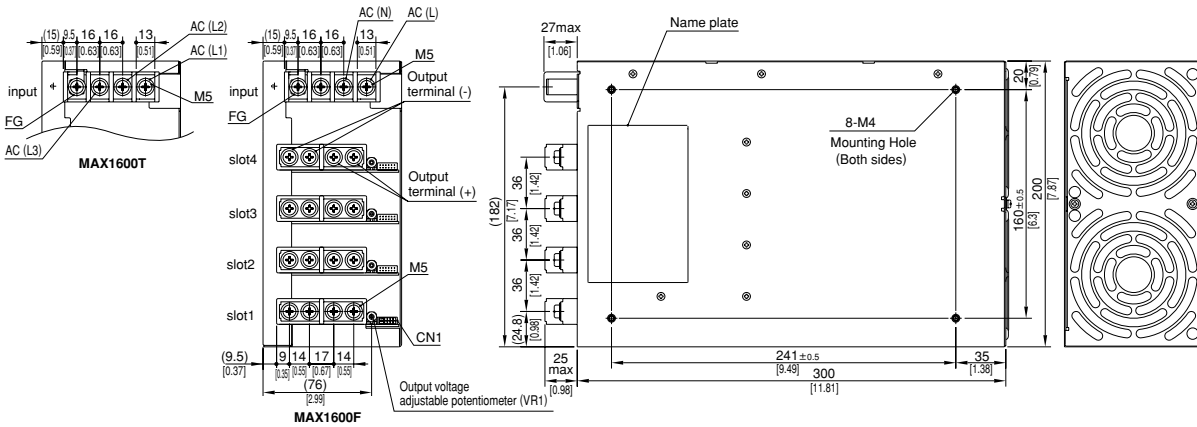

MAX

- ※ Tolerance : ± 1 [± 0.04]
- ※ Weight : 7kg max
- ※ PCB Material/thickness : FR-4/1.6mm [0.06]
- ※ Chassis material : Stainless steel SUS430
- ※ Dimensions in mm, [] = inches
- ※ Mounting torque : $1.5N \cdot m$ (16kgf · cm) max
- ※ Keep drawing current per terminal below 80A of output terminal.
- ※ The housing for the remote sensing unused is mounted on CN1 of each output module.
However, when the output module is connected in parallel, the housing is mounted on only master output module.
- ※ Output terminal covers are appended.

MAX3200T external view

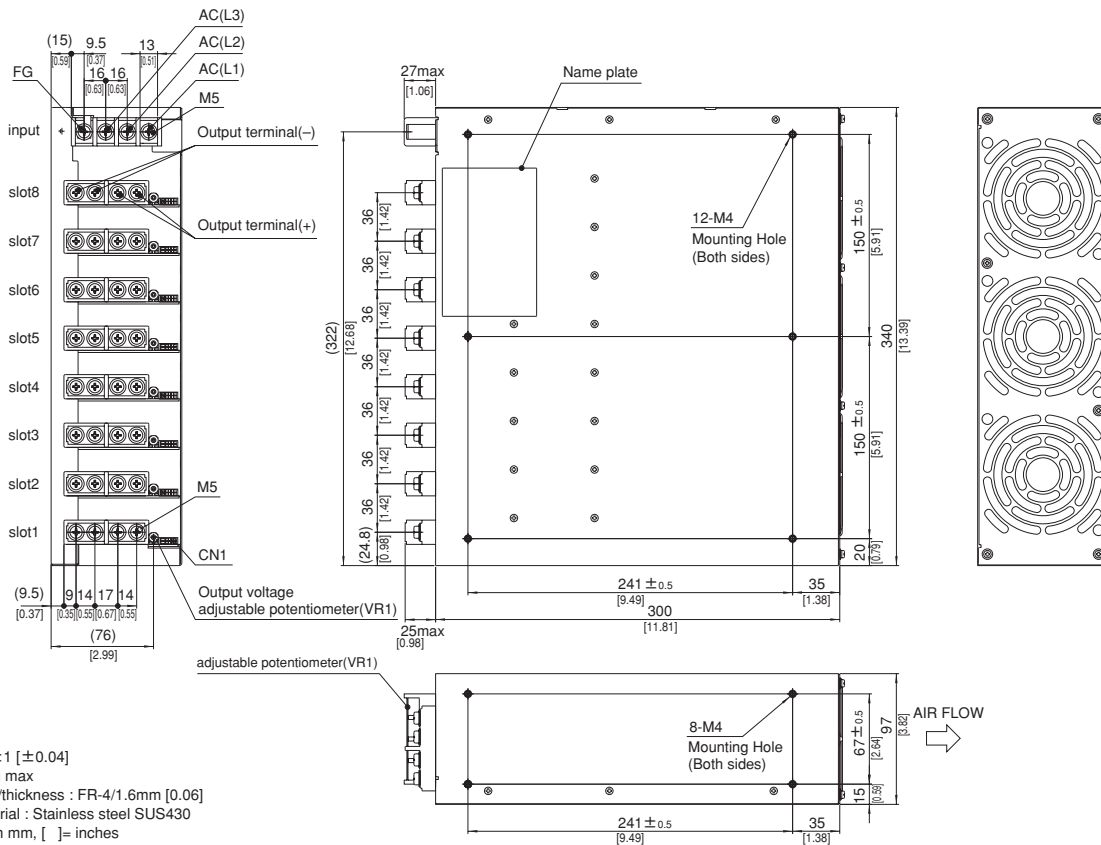

- ※ Tolerance : ± 1 [± 0.04]
- ※ Weight : 14kg max
- ※ PCB Material/thickness : FR-4/1.6mm [0.06]
- ※ Chassis material : Stainless steel SUS430
- ※ Dimensions in mm, [] = inches
- ※ Mounting torque : $1.5N \cdot m$ (16kgf · cm) max
- ※ Keep drawing current per terminal below 80A of output terminal.
- ※ The housing for the remote sensing unused is mounted on CN1 of each output module.
However, when the output module is connected in parallel, the housing is mounted on only master output module.
- ※ Output terminal covers are appended.

Function connector (CN1) pinassign

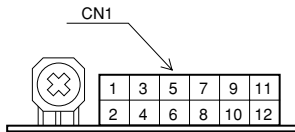

Mating connector and terminal of output module CN1

	Connector	Mating connector	Terminal	Mfr.
CN1	S12B-PHDSS	PHDR-12VS	Chain : SPHD-002T-P0.5	J.S.T
			Loose : BPHD-001T-P0.5 : BPHD-002T-P0.5*1	

*1 Ratchet Hand is nothing

Pin connection and function of output module CN1

Pin No.	Function
1	+M : +Output voltage monitoring
2	-M : -Output voltage monitoring
3	+S : +Remote sensing
4	-S : -Remote sensing, Signal ground
5	TRM : Adjustment of output Voltage
6	-S : -Remote sensing, Signal ground
7	RC2 : Remote ON/OFF
8	-S : -Remote sensing, Signal ground
9	RC3 : Remote ON/OFF
10	ALM : Fan alarm (and open phase alarm)*
11	IOG : Inverter operation monitor
12	TMP : Thermal detection signal

*MAX1600T / MAX3200T